

VISTA

One-Piece Toilet

C-2610

Product Features

- Vitreous china one-piece toilet, with skirted trapway
- Chair-height (16-1/2"), elongated bowl
- MicroGlaze™ anti-microbial, non-staining glaze
- 12" (305 mm) rough-in

EcoQUATTRO™ Flushing System

- High-performance, gravity flush
- 1.28 gallons (4.8 liters) per flush – EPA WaterSense, high-efficiency toilet (HET)
- Fully-glazed, 2-1/8" internal trapway
- Oversized 3" flush valve
- Large 9" x 7" water surface area and optimized rim jets, for an exceptionally clean bowl

Accessories Included

- Toilet seat and cover, with slow-close hinges
- Solid metal trip lever

Quality Assurance

- Factory flush-tested
- Limited lifetime product warranty



Dimensional Diagram

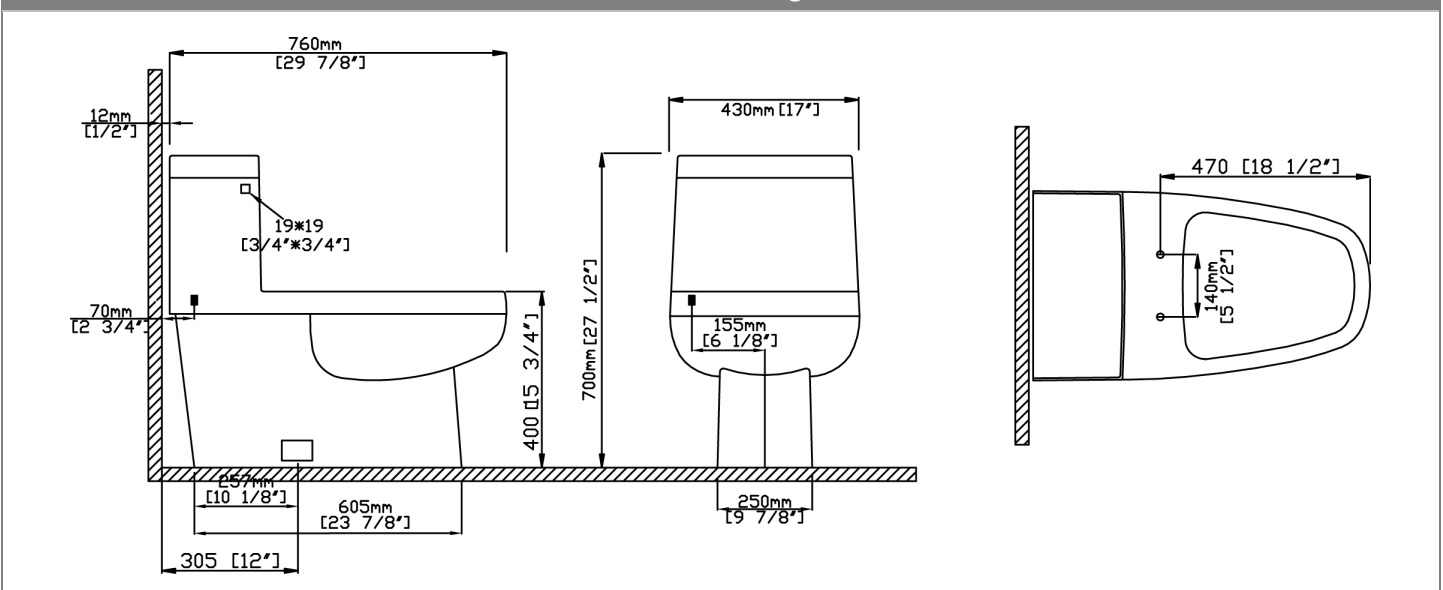

IMPORTANT: Dimensions are nominal and may vary within the range of tolerance per by NSI Standard A112.19.2. These measurements are subject to change. No responsibility is assumed for use of superseded or voided pages.

PRODUCT OPTIONS & PARTS



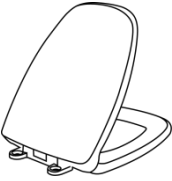

Glaze Color Options

 .01 White	 .06 Biscuit	 .05 Black
---	---	---

Toilet Seat Options



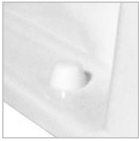

 S-222 (Standard)	SB-222 Seat Bolts	
--	--------------------------	--

Tank Levers & Trim Options

 F-74 (Standard)	Side-Mount Tank Lever .500 Chrome (Standard) .502 Polished Nickel .503 Satin Nickel .504 Polished Brass .01 White Enamel	 F-75	Side-Mount Tank Lever .500 Chrome (Standard) .502 Polished Nickel .503 Satin Nickel .504 Polished Brass	
 MC-505 (Standard)	Floor Bolt Caps, Plastic .01 White .06 Biscuit .05 Black	 MC-507	Floor Bolt Caps, Brass .500 Chrome (Standard) .502 Polished Nickel .503 Satin Nickel .504 Polished Brass .508 Venetian Bronze .01 White Enamel	

Metal Finish Options

Not all finishes are available for all parts. Refer to the finish options listed above for each part.

 .500 Polished Chrome	 .502 Polished Nickel	 .503 Satin Nickel	 .504 Polished Brass	 .01 White Enamel
---	---	--	--	---

Valve & Installation Parts

Fill Valve	Flush Valve	Flapper	Mounting Bolts
VL-3801	VH-4801.13	9400.516	MB-111

Compliance Certifications

<ul style="list-style-type: none"> • ASME A112.19.2M • CSA B45.1 		<p>Meets the Americans With Disabilities Act (ADA) guidelines and ANSI A117.1 requirements for accessible building facilities. Check local codes.</p>
--	---	--