

CADENCE

Two-Piece Toilet

C-3170 Bowl, T-3170 Tank

Product Features

- Vitreous china two-piece toilet, with skirted trapway
- Chair-height (16-1/2"), elongated bowl
- MicroGlaze™ anti-microbial, non-staining glaze
- 12" (305 mm) rough-in

EcoQUATTRO™ Flushing System

- High-performance, gravity flush
- 1.28 gallons (4.8 liters) per flush – EPA WaterSense, high-efficiency toilet (HET)
- Fully-glazed, 2-1/8" internal trapway
- Oversized 3" flush valve
- Large 9" x 7" water surface area and optimized rim jets, for an exceptionally clean bowl

Accessories Included

- Toilet seat and cover, with slow-close hinges
- Solid metal trip lever

Quality Assurance

- Factory flush-tested
- Limited lifetime product warranty



Dimensional Diagram

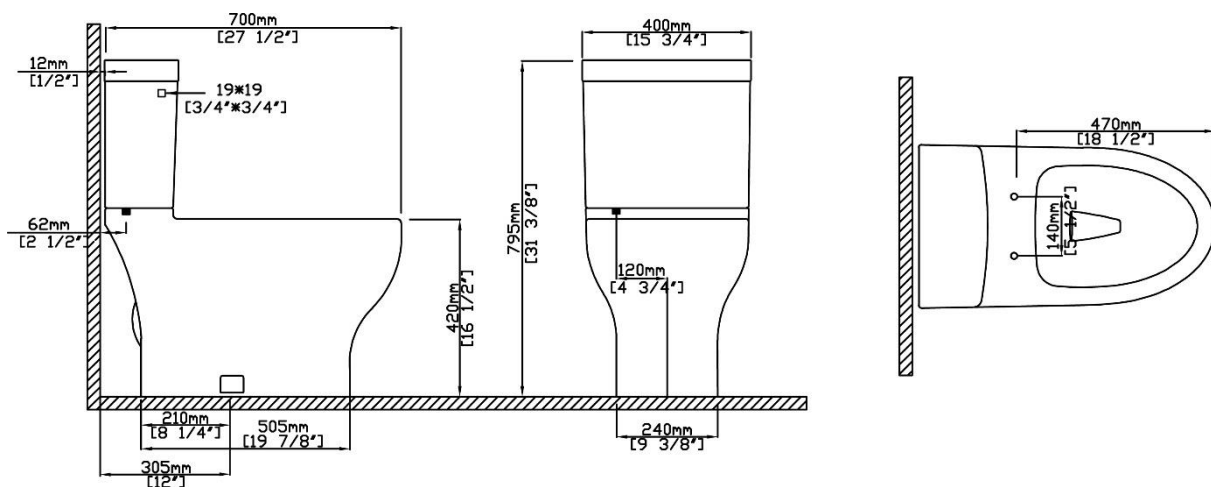







IMPORTANT: Dimensions are nominal and may vary within the range of tolerance per by NSI Standard A112.19.2. These measurements are subject to change. No responsibility is assumed for use of superseded or voided pages.

PRODUCT OPTIONS & PARTS

Glaze Colors		
 .01 White	 .06 Biscuit	 .05 Black

Toilet Seats		
 S-232 (Standard)		

Tank Levers & Available Finishes					
 F-72 (Standard)					
.500 Chrome (Standard) .502 Polished Nickel .503 Satin Nickel	.504 Polished Brass .01 White Enamel				
 .500 Polished Chrome	 .502 Polished Nickel	 .503 Satin Nickel	 .504 Polished Brass	 .01 White Enamel	

Valve & Installation Parts				
Fill Valve	Flush Valve	Flapper	Tank-to-Bowl Kit	Mounting Bolts
VL-3802	VH-4802.17	9400.516.00	9400.513.00	MB-111

Compliance Certifications	
Meets or exceeds the following specifications: <ul style="list-style-type: none"> ASME A112.19.2M CSA B45.1 	 Meets the Americans With Disabilities Act guidelines and ANSI A117.1 requirements for accessible building facilities. Check local codes.